

1 Pyramide

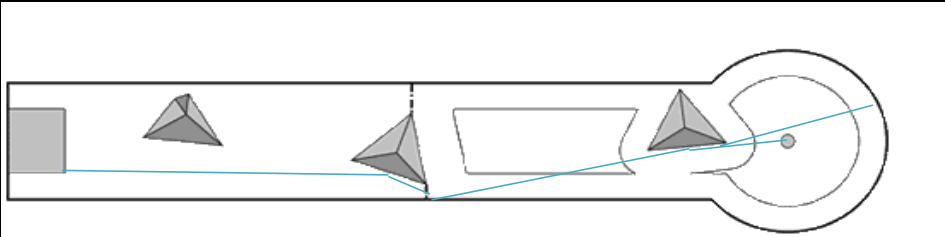

von oben gegen zweite Pyramide, nicht zu langsam spielen.

Rücklauf von links

2 Passage

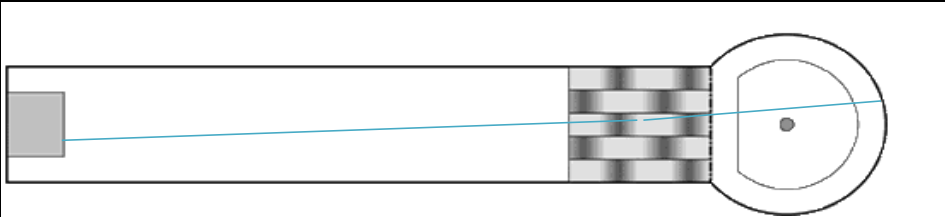

1 - 2 Loch nach oben legen , dann zur Mitte spielen

3 Kassler V

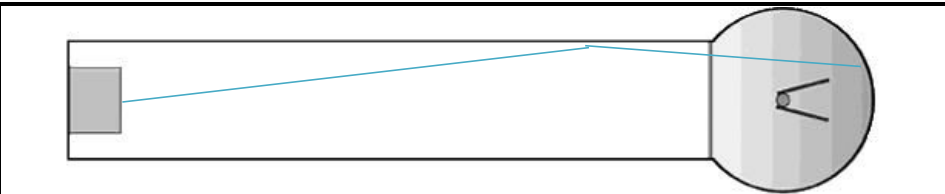

am besten mit Vorbande , zieht nach links

4 Schleife

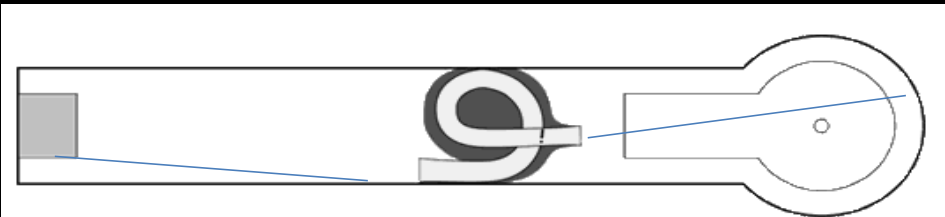

mit Vorbande , Rücklauf links vorbei

5 Brücke

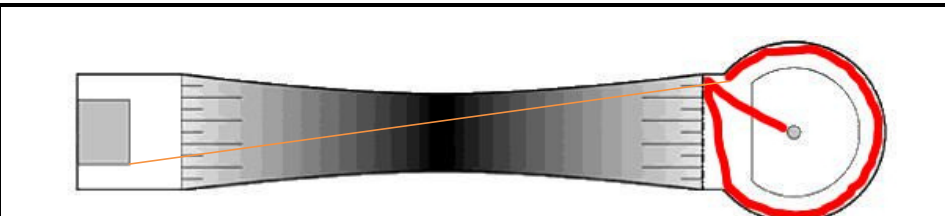

von oben , muß sauber gespielt werden, am besten unten noch die Bande berühren, sonst läuft er unten durch.

6 Winkel

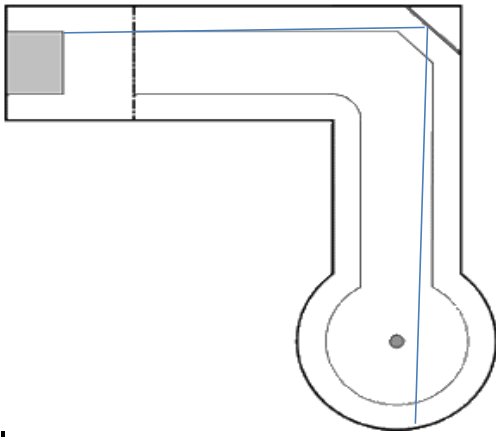

gerade ,nicht zu tief anspielen

Rücklauf links

7 Röhre

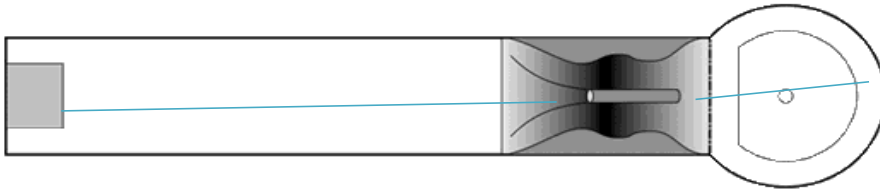

zwei Loch hoch legen,dann zur Mitte spielen,Rohr schluckt sehr gut

8 Labby

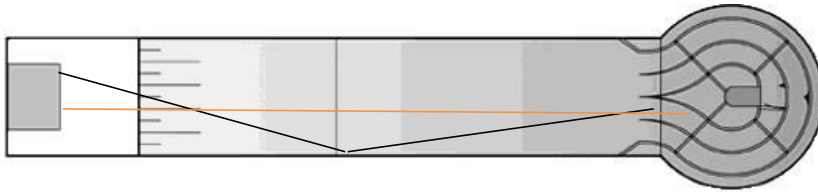

gerade : normal

Bande: normal

9 Raute

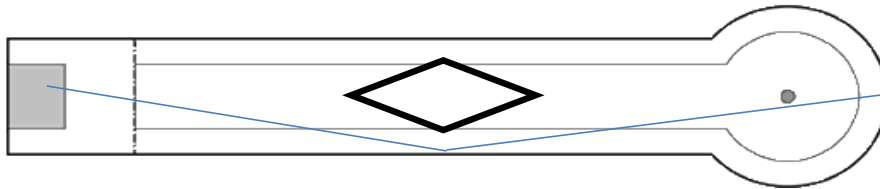

10 Fenster

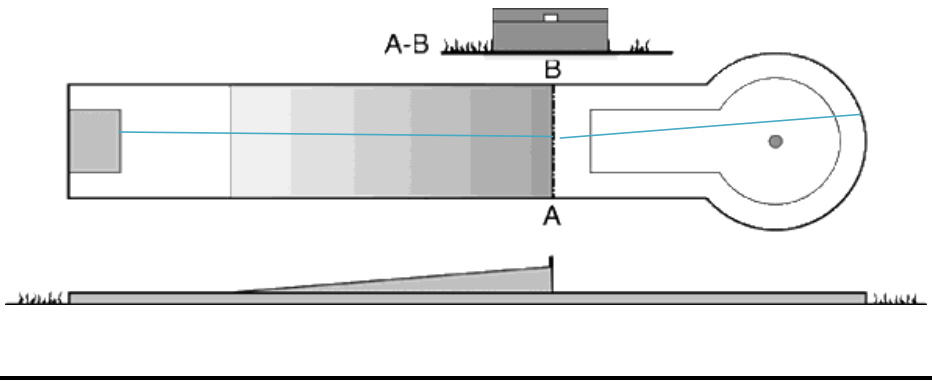

11 Mittelhügel



Lieblingsball

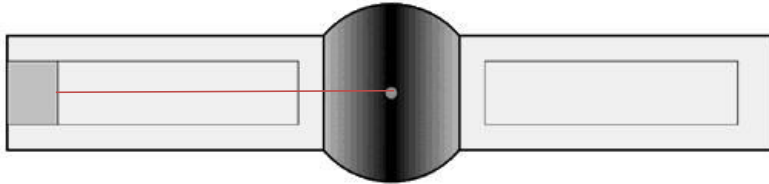

ein Loch runter , dann gerade

12 Blumenkästen

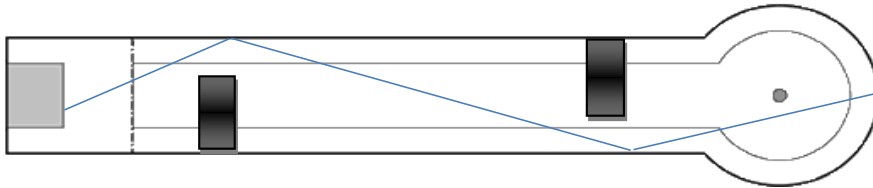

13 Gentlemen

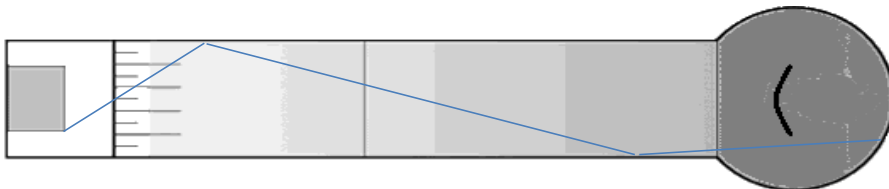

14 Bodenwelle

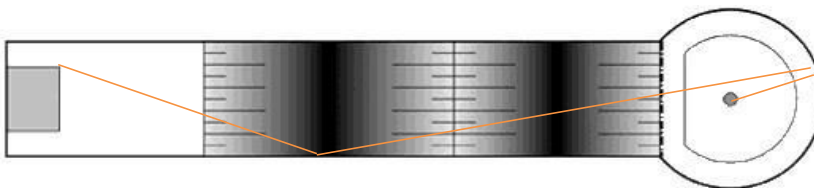

von unten mit Unterschnitt

15 Netz

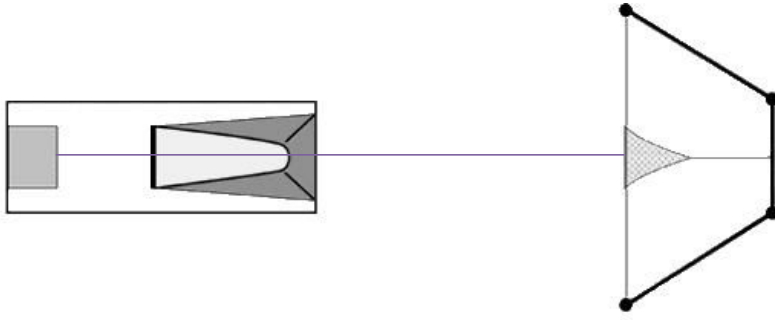

normal

16 Hochplateu

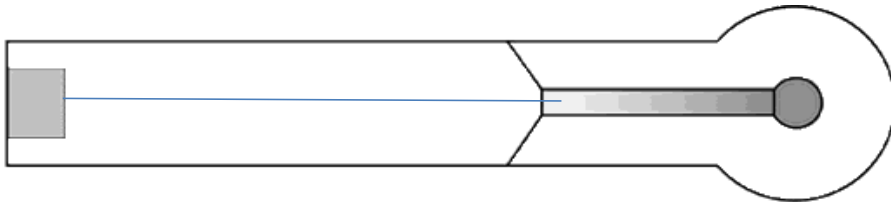

17 Doppelkeile

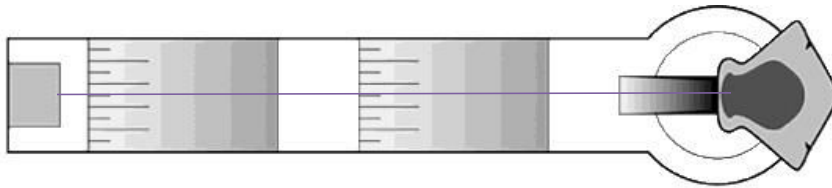

normal

18 Blitz

